

If there is film / Wenn Folie vorhanden ist /
Présence d'un film / Se è presente la pellicola

Make sure to peel off the blue film before installing the Washlet. Otherwise the bowl surface will not be able to be protected from the silicon seal material. /
Die blaue Folie vor der Installation des Washlet abziehen. Andernfalls kann die Oberfläche des Beckens nicht vor dem Silikonabdichtungsmaterial geschützt werden. /
Veuillez à retirer le film bleu avant d'installer le bidet. Sinon, il ne sera pas possible de protéger la surface de la cuvette du matériau d'étanchéité à base de silicone. /
Staccare la pellicola blu prima di installare il Washlet. In caso contrario la superficie della tazza non può essere protetta dal materiale di tenuta in silicone.

If there is film / Wenn Folie vorhanden ist /
Présence d'un film / Se è presente la pellicola

Make sure to peel off the transparent film after installing the Washlet. Otherwise the bowl surface will not be able to be protected from the silicon seal material. /
Die durchsichtige Folie nach der Installation des Washlet abziehen. Andernfalls kann die Oberfläche des Beckens nicht vor dem Silikonabdichtungsmaterial geschützt werden. /
Veuillez à retirer le film transparent après avoir installé le bidet. Sinon, il ne sera pas possible de protéger la surface de la cuvette du matériau d'étanchéité à base de silicone. /
Staccare la pellicola trasparente dopo l'installazione del Washlet. In caso contrario la superficie della tazza non può essere protetta dal materiale di tenuta in silicone.

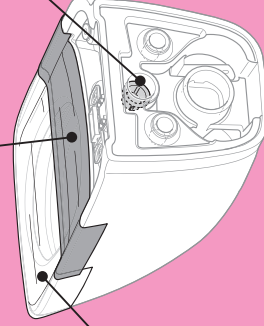
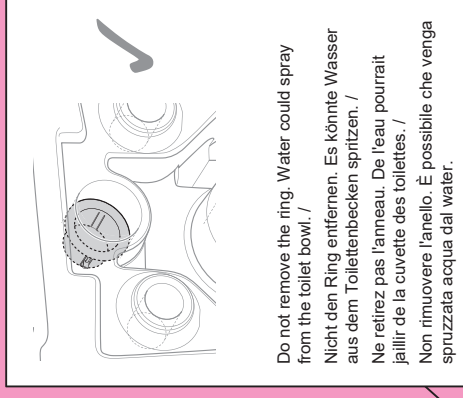

TOTO Europe GmbH

Zollhof 2, 40221 Düsseldorf Germany
Phone : 49-211-27308-200 Fax : 49-211-27308-202

TOTO

Wall mounted toilet bowl /
Wandmontierte Toilettenbecken /
WC suspendu /
Water a parete



H0B499C
2023.8

(This code is for manufacturer management use.) /
(Dieser Code dient zur Verwendung durch den Hersteller zu Verwaltungszwecken.) /
(Ce code est réservé à l'usage du fabricant à des fins de gestion.) /
(Questo codice è per la gestione del produttore.)

Installation Guide
Installationsanleitung
Guide d'installation
Guida per l'installazione

Required

Before installing the toilet bowl, attach the shutoff valve, etc..
(The shutoff valve, etc. cannot be attached once the toilet bowl is attached.)
*Only when installing a WASHLET unit

Zwingend erforderlich

Vor der Installation des Toilettenbeckens das Absperrventil usw. anbringen.
(Das Absperrventil usw. kann nicht nach Befestigen des Toilettenbeckens angebracht werden.)
*Gilt nur für Installation einer WASHLET-Einheit

Obligatoire

Avant d'installer la cuvette des toilettes, fixez le robinet d'arrêt, etc.
(Vous ne pouvez plus fixer le robinet d'arrêt, etc. une fois la cuvette des toilettes fixée.)
*Uniquement en cas d'installation d'un BIDET

Obbligatorio

Prima di installare il water, collegare la valvola di chiusura ecc.
(La valvola di chiusura ecc. non può essere collegata una volta fissato il water.)
*Solo per l'installazione di un'unità WASHLET

Flow of installation (See these instructions regarding  parts.)

Ablauf der Installation (Siehe diese Anweisungen bezüglich  Teilen.)

Processus d'installation (voir les instructions relatives aux pièces  .)

Procedura di installazione (vedere le istruzioni riguardanti le parti ).

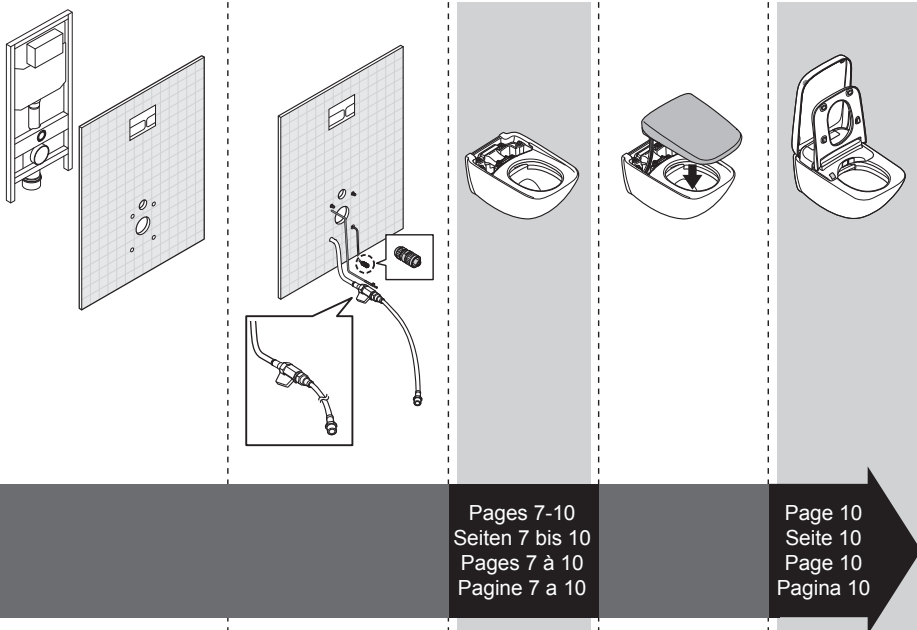
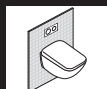
**EN**





Perform the installation work properly according to this Installation Guide so that the product can function well. After installation, fully explain how to use it to your customer.

Cautions and warnings (Always observe these warnings.)



Before installation, read these "Cautions and warnings" carefully and attach the equipment correctly. This manual uses various indications to guide safe installation of the product and to prevent injury to customers or other people and damage to property. This product should be installed by a professional. The indications and their meanings are as follows.

Symbol example	Meaning of symbol
 CAUTION	This indicates that misoperation could result in injury or physical damage.

Items to be observed are classified by type and explained with the following pictograms.

	The  symbol indicates something that is prohibited.		The  symbol indicates something that must be done.
---	--	---	---

CAUTION

	Do not subject the toilet to strong forces or impacts. Otherwise, the toilet may break causing injury or leaks that may damage property.
	Be sure to use the included or specified parts for installation work. Otherwise, the product may not be installed properly. Carry out the installation work according to this installation manual. Otherwise, damage caused by water leaks may occur. Be sure to carry and install this product with at least two people. Otherwise, you could injure your lower back or drop the toilet bowl, causing damage and injury.

DE





Führen Sie die Installationsarbeiten entsprechend dieser Anleitung durch, um sicherzustellen, dass das Produkt richtig funktioniert. Geben Sie dem Kunden nach der Installation genaue Anweisungen zur Benutzung.

Vorsichtsmaßnahmen und Warnungen (Beachten Sie diese Warnungen immer.)

Bitte lesen Sie diese „Vorsichtsmaßnahmen und Warnungen“ vor der Installation aufmerksam durch und bringen Sie das Produkt entsprechend an. Diese Anleitung enthält zahlreiche Hinweise zur sicheren Installation des Produkts sowie Anmerkungen, wie Sie Verletzungen und Schäden vermeiden können. Das Produkt sollte von einem professionellen Installateur installiert werden. Die Hinweise und ihre Bedeutung sind im Folgenden erklärt.

Symbol-Beispiel	Bedeutung des Symbols
 VORSICHT	Dies weist darauf hin, dass eine falsche Bedienung zu körperlichen Verletzungen oder Sachschäden führen kann.

Zu beachtende Punkte sind nach Typ klassifiziert und anhand der folgenden Piktogramme erläutert.

	Mit  werden verbotene Arbeitsinhalte gekennzeichnet.		Mit  werden unbedingt auszuführende Arbeitsinhalte gekennzeichnet.
---	---	---	---

VORSICHT

	Setzen Sie die Toilette keinen starken Krafteinwirkungen oder Stößen aus. Die Toilette könnte beschädigt werden und so zu Verletzungen oder zu Sachschäden durch Wasserlecks führen.
	Verwenden Sie für die Installationsarbeiten unbedingt die mitgelieferten bzw. vorgeschriebenen Teile. Andernfalls besteht die Möglichkeit, dass eine ordnungsgemäße Installation nicht möglich ist. Bitte führen Sie die Installationsarbeiten der Anleitung folgend aus. Andernfalls könnte es zu Wasserlecks kommen.
	Für den Transport und die Installation des Produkts sind mindestens zwei Personen erforderlich. Andernfalls kann es zu Verletzungen des unteren Rückens beim Transport oder zu Schäden und/oder Verletzungen aufgrund eines fallengelassenen Toilettenbeckens kommen.

Exécutez correctement l'installation en suivant ces instructions de montage afin de vous assurer que le produit fonctionne convenablement. Une fois l'installation terminée, donnez des instructions précises au client.

Mises en garde et avertissements (veuillez toujours respecter ces avertissements.)

Avant l'installation, lisez attentivement les « Mises en garde et avertissements » et montez convenablement l'appareil. Ces instructions de montage contiennent diverses indications pour une installation sûre du produit et pour éviter toute blessure et tout dommage. Ce produit doit être installé par un professionnel. Les indications et leurs significations sont expliquées ci-après.

Exemple de symbole	Signification du symbole
 MISE EN GARDE	Ce symbole indique que toute utilisation incorrecte peut entraîner des blessures ou des dommages matériels.

Les articles devant être observés sont classés par type et sont expliqués au moyen des pictogrammes suivants.

	Le symbole  indique une interdiction.		Le symbole  indique qu'une intervention est requise.
--	--	---	---

MISE EN GARDE

	Ne soumettez pas le WC à des forces ou à des chocs. Sinon, le WC pourrait être endommagé et entraîner ainsi des blessures ou des dommages matériels dus à des fuites.
	Veillez à bien utiliser les pièces spécifiées ou fournies pour les travaux d'installation. Sinon, le produit peut ne pas être correctement installé.
	Effectuez les travaux d'installation conformément à ces instructions de montage. Sinon, des fuites d'eau peuvent survenir.
	Assurez-vous de porter et d'installer ce produit avec deux personnes au moins. Sinon, vous pourriez vous blesser le dos ou laisser tomber la cuvette des toilettes, ce qui entraînerait des dommages ou des blessures.

Eseguire il lavoro di installazione correttamente seguendo questa Guida per l'installazione, in modo che il prodotto possa funzionare correttamente. Dopo l'installazione, spiegare nei dettagli al cliente come utilizzare il prodotto.

Precauzioni e avvertenze (osservare sempre queste avvertenze).





Prima dell'installazione, si prega di leggere attentamente queste "Precauzioni e avvertenze" per un montaggio corretto dell'apparecchio. Questo manuale utilizza varie indicazioni per l'installazione sicura del prodotto e per la prevenzione di lesioni personali e danni materiali. Questo prodotto deve essere installato da un professionista. Le indicazioni e i relativi significati sono riportati di seguito.

Indicazione	Significato del simbolo
 ATTENZIONE	Questo indica che un'operazione errata può avere come conseguenza lesioni o danni materiali.







Le tipologie di voci da osservare sono classificate e spiegate da pittogrammi come viene riportato di seguito.

	Il simbolo  indica un'operazione vietata.		Il simbolo  indica un'operazione che è necessario eseguire.
--	--	---	--

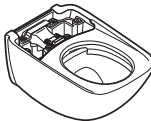
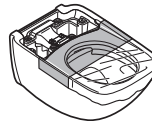
ATTENZIONE

	Non sottoporre il Washlet a forze eccessive o urti. In caso contrario, il Washlet potrebbe essere rotto provocando lesioni personali o perdite di acqua che causano danni materiali.
	Assicurarsi di utilizzare le parti incluse o specificate per l'intervento di installazione. In caso contrario, il prodotto può non essere installato correttamente.
	Eseguire l'intervento di installazione in conformità a questo manuale per l'installazione. In caso contrario, possono verificarsi danni causati da perdite d'acqua.
	Il trasporto e l'installazione di questo prodotto devono essere effettuati da almeno due persone. In caso contrario si possono soffrire lesioni nella zona lombare o si può far cadere il water, con conseguenti danni e lesioni.

Included Parts / Mitgelieferte Teile / Pièces fournies / Parti incluse

				Toilet bowl on which the protective film is attached / Toilettenbecken mit angebrachter Schutzfolie / Cuvette des toilettes sur laquelle est fixée la pellicule protectrice / Water con pellicola di protezione	
CW927PZY or CW928PZY CW927PZY oder CW928PZY CW927PZY ou CW928PZY CW927PZY o CW928PZY		* Do not remove the protective sheet until installation of Washlet. / * Die Schutzabdeckung vor der Installation des Washlet nicht entfernen. / * Ne pas retirer la pellicule protectrice avant l'installation du bidet. / * Non rimuovere la pellicola di protezione fino all'installazione del Washlet.			
A-2	B-1		B-2	B-3	B-4
					



* The product may be slightly different in shape than the product shown in the figure depending on the model. /

* Je nach Modell kann die Form des Produkts leicht von der Abbildung abweichen. /

* En fonction du modèle, la forme du produit peut être légèrement différente de celle illustrée. /

* Secondo il modello, il prodotto può avere una forma leggermente diversa da quella mostrata nell'illustrazione.

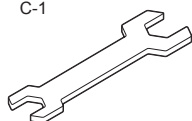
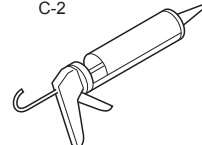
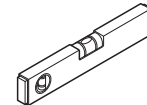
Required tools / Erforderliches Werkzeug / Outils requis / Utensili necessari

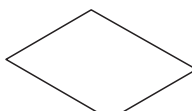
C-1	C-2	C-3	C-4
			
C-5 Curing sheet / Eine Unterlage / Feuille de prise / Foglio di plastica			
			

Before Installing / Vor der Installation / Avant l'installation / Prima dell'installazione

- Make sure that the surface of the bowl don't in contact with silicone. / Die Oberfläche des Beckens darf nicht in Kontakt mit Silikon kommen. / S'assurer que la surface de la cuvette n'entre pas en contact avec le silicone. / Verificare che la superficie della tazza non entri in contatto con il silicone.

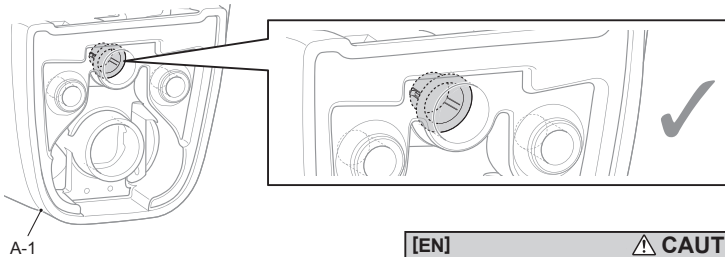
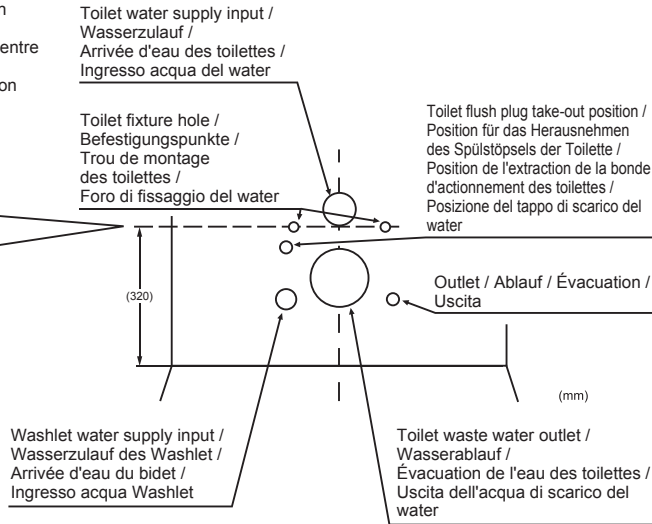
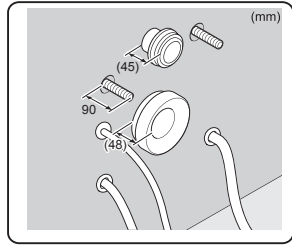

[EN]	CAUTION
Required	Confirm that the part shown in the figure above is installed to the toilet bowl (A-1). If the toilet bowl is installed without this part, water could spray from the toilet bowl.
[DE]	VORSICHT
Zwingend erforderlich	Überprüfen Sie, ob das in der Abbildung oben dargestellte Teil im Toilettenbecken (A-1) angebracht ist. Wenn das Toilettenbecken ohne dieses Teil montiert wird, könnte Wasser aus dem Toilettenbecken spritzen
[FR]	MISE EN GARDE
Requis	Vérifier que la pièce mentionnée dans la figure ci-dessus est bien installée avec la cuvette des toilettes (A-1). Si la cuvette est installée sans cette pièce, de l'eau pourrait jaillir de la cuvette.
[IT]	ATTENZIONE
Obbligatorio	Verificare che il componente illustrato nella figura sopra sia installato sul water (A-1). Se si installa il water senza questo componente, l'acqua potrebbe fuoriuscire dal water.

Meaning of the indications / Bedeutung der Hinweise / Signification des indications / Significato delle indicazioni

[EN]

↓ : Task that must be conducted by the installer

👁️ : Work that requires confirmation

⏴ : Shows the work sequence

[DE]

↓ : Diese Aufgabe ist vom Installateur auszuführen

👁️ : Bei dieser Tätigkeit ist eine Bestätigung erforderlich

⏴ : Zeigt den Arbeitsablauf an

[FR]

↓ : Tâche incombant à l'installateur

👁️ : Tâche exigeant une vérification

⏴ : Indique l'ordre de suivi de la procédure

[IT]

↓ : Intervento che deve essere effettuato dall'installatore

👁️ : Intervento che richiede conferma

⏴ : Mostra la sequenza dell'intervento

Installing the NEOREST / Installation des NEOREST / Installazione del NEOREST

I

Close the main valve before working. /

Vor der Arbeit das Hauptventil schließen. /

Fermez la vanne principale avant de commencer l'installation. /

Prima dell'intervento chiudere la valvola principale.

Before installing the toilet bowl, lay a curing sheet (C-5) under the packaging material and construction it. /

Vor der Installation des Toilettenbeckens eine Unterlage (C-5) unter das Verpackungsmaterial legen und den Zusammenbau darauf vornehmen. /

Avant d'installer la cuvette des toilettes, disposez une feuille de prise (C-5) sous le matériau d'emballage et installez-la. /

Prima di installare il water, disporre un foglio di plastica (C-5) sotto il materiale nella confezione.

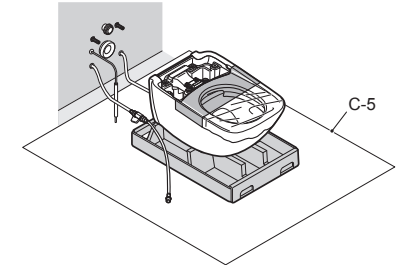

2

When placing the toilet bowl, be careful not to pinch the cords. /

Beim Aufstellen des Toilettenbeckens darauf achten, die Kabel nicht zu quetschen. /

Lors de la pose de la cuvette des toilettes, veuillez à ne pas pincer les câbles. /

Quando viene posizionato il water, fare attenzione a non pizzicare le tubazioni. /

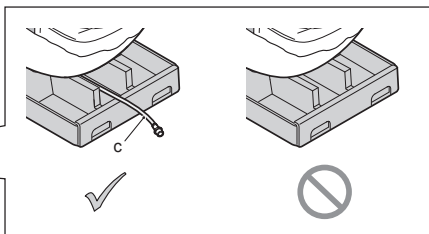
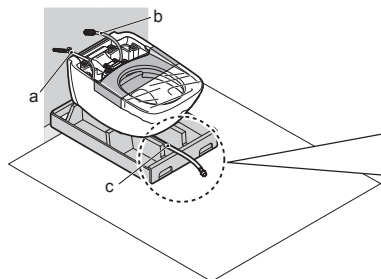
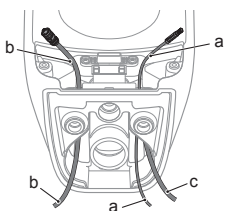
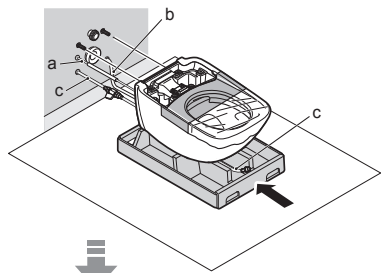

EN	⚠ CAUTION
Required	Connect the main unit securely to the toilet's water supply input and wastewater output. Incomplete connection could cause foul odours or water to leak.
DE	⚠ VORSICHT
Zwingend erforderlich	Die Haupteinheit sicher an den Wasserzulauf und den Abwasserablauf der Toilette anschließen. Eine unvollständige Verbindung kann zu üblen Gerüchen und Wasserlecks führen.
FR	⚠ MISE EN GARDE
Obligatoire	Raccordez fermement l'unité principale à l'arrivée d'eau des toilettes et à l'évacuation des eaux usées. Un raccord incomplet peut entraîner de mauvaises odeurs ou une fuite d'eau.
IT	⚠ ATTENZIONE
Obbligatorio	Collegare saldamente l'unità principale all'ingresso dell'acqua e all'uscita dell'acqua di scarico del water. Una connessione allentata può causare la fuoriuscita di cattivi odori o acqua.

3

Temporarily fasten the toilet. /
Die Toilette temporär befestigen. /
Attachez provisoirement les toilettes. /
Fissare temporaneamente il water.

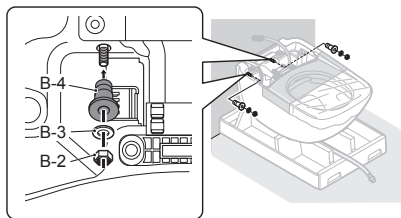

4

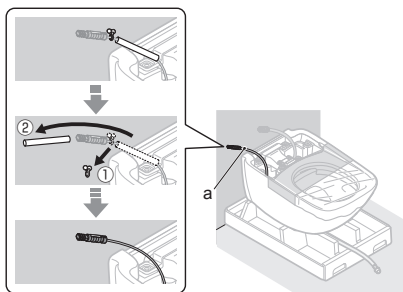

5

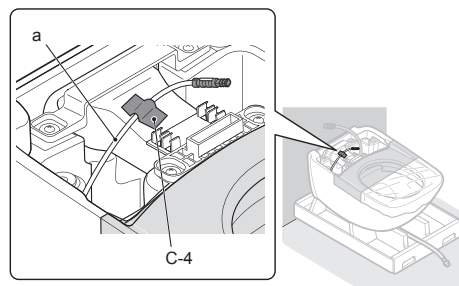

6

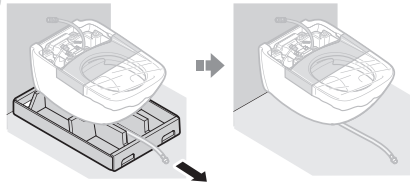

7

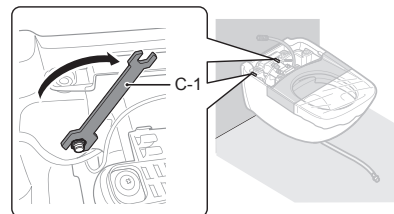

8

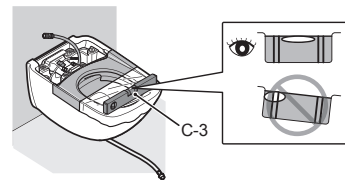

9

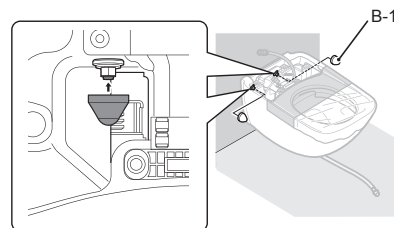

10

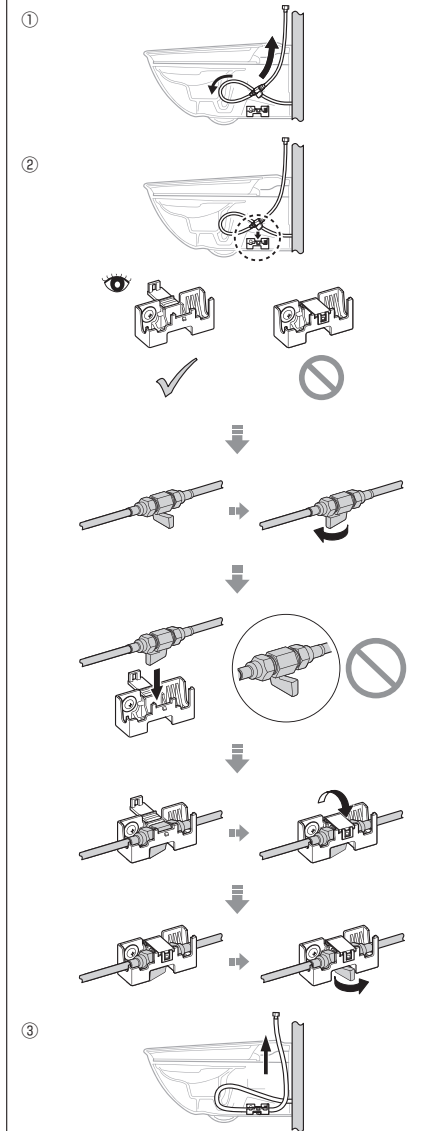
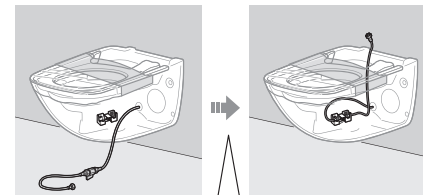

11

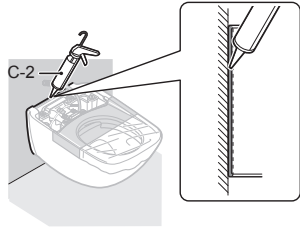

12

Mount the Washlet main unit according to the installation manual included in the package of the Washlet main unit. /

Die Washlet-Haupteinheit gemäß der in der Verpackung der Washlet-Haupteinheit enthaltenen Installationsanleitung montieren. /

Montez l'unité principale du bidet conformément aux instructions d'installation fournies avec le kit de l'unité principale du bidet. /

Montare l'unità Washlet principale secondo il manuale di installazione incluso nella relativa confezione.

13

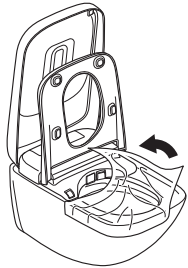

14

• After the trial-run (flush) of the toilet bowl, check the toilet bowl inside for foreign matter such as chips of cut pipe, etc. Foreign matters such as transmitted rust can stick to the sides.

• Make sure that there are no scratches in the gray area of the ceramic surface. If metallic objects (watchbands, belt buckles, etc.) strongly contacts or scrapes against the surface of the ceramic, a black or silver streak may be left. If marked by such a streak, remove it by gently rubbing the surface with an abrasive detergent, etc.

• After installation, unseen dirt (oil or adhesive for piping) may remain in the toilet bowl. Be sure to wipe it off using a non-abrasive neutral detergent for toilets. Otherwise, the toilet bowl surface may not flush completely clean.

• If silicone adhere to the surface of the toilet bowl, please contact TOTO.



Gray area of earthenware

- Nach einem Probebetrieb (Spülen) des Toilettenbeckens das Toilettenbecken auf Fremdkörper, wie Späne oder Rohrstücke etc. prüfen. Fremdkörper wie Rost können sich an den Seiten festsetzen.
- Es dürfen sich keine Kratzer im grauen Bereich der Keramik befinden. Wenn Objekte aus Metall (Uhrbänder, Gürtelschnallen usw.) in heftigen Kontakt mit der Keramikoberfläche kommen oder gegen diese schaben, kann ein silberfarbener Strich zurückbleiben. Ein derartiger Strich kann durch sanftes Reiben der Oberfläche mit einem Scheuermittel entfernt werden.
- Nach der Installation kann unbemerkt Schmutz (Öl oder Klebstoff für Rohrleitungen) im Toilettenbecken zurückbleiben. Dieser muss mit einem nicht scheuernden Reinigungsmittel für Toiletten abgewischt werden. Andernfalls wird das Toilettenbecken beim Spülen möglicherweise nicht vollkommen sauber.
- Wenn Silikon an der Oberfläche des Toilettenbeckens haftet, bitte TOTO kontaktieren.



Grauer Bereich des Steinguts

- Après l'essai de fonctionnement (chasse) de la cuvette des toilettes, vérifiez l'intérieur de la cuvette à la recherche de corps étrangers tels que des morceaux de tuyau découpé, etc. Des corps étrangers tels que de la rouille déposée peuvent adhérer aux parois latérales.
- Assurez-vous qu'il n'y a pas de rayures sur la partie grise de la terre cuite. Si des objets métalliques (bracelets de montre, boucles de ceinture, etc.) heurtaient ou éraflaient la surface de la terre cuite, une marque noire ou argentée pourrait apparaître. S'il y a une telle marque, retirez-la en frottant doucement la surface avec un détergent abrasif, etc.
- Après l'installation, de la saleté (huile ou adhésif pour tuyauterie) cachée peut subsister dans la cuvette des toilettes. Veillez à l'essuyer à l'aide d'un détergent neutre non abrasif pour toilettes. Sinon, une chasse pourrait ne pas nettoyer totalement la surface de la cuvette.
- Contactez TOTO si du silicone colle à la surface de la cuvette des toilettes.



Zone grise de la terre cuite

- Dopo il collaudo (scarico) del water, controllare che nella tazza non siano presenti materiali estranei quali trucioli di tubi tagliati ecc. I materiali estranei possono arrugginire e aderire alle superfici.
- Verificare che non siano presenti graffi nell'area grigia della ceramica. Se oggetti metallici (cinturini di orologi, fibbie di cinture ecc.) colpiscono o graffiano la superficie in ceramica, possono lasciare una striscia nera o argentata. Tali strisce possono essere eliminate sfregando la superficie con un detergente abrasivo.
- Dopo l'installazione, nella tazza può restare sporizia non visibile (olio o adesivo per tubazioni). Eliminarla utilizzando un detergente neutro per WC non abrasivo. In caso contrario la superficie del water può non essere completamente pulita.
- Se sulla superficie del water aderisce silicone, contattare TOTO.



Area grigia della ceramica